

LET'S MAKE A CROCODILE

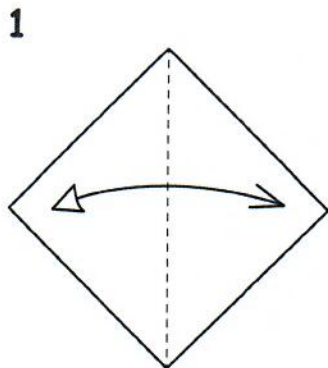

Fold and unfold.

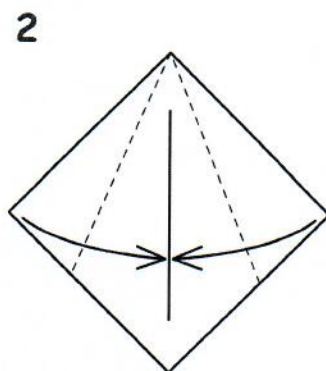

Fold to the center.

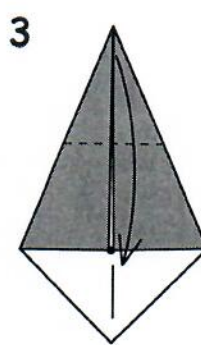

Fold down a little below the dot.

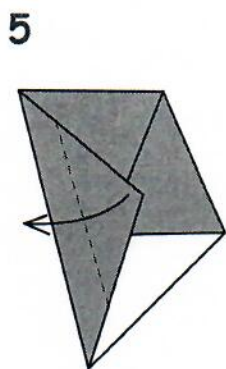
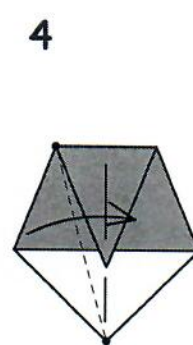

Repeat steps 4-5 on the right.

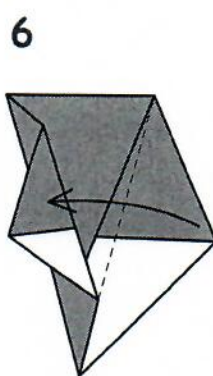

Pull out the hidden flap.

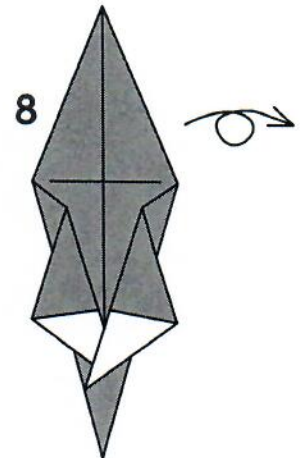

Pleat folds.

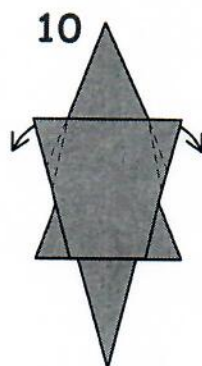

Pleat folds.

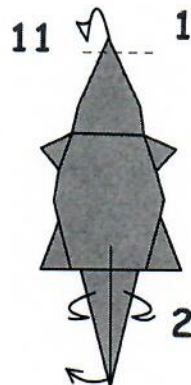

1. Fold the tip behind.
2. Bend and curl the tail a little bit.

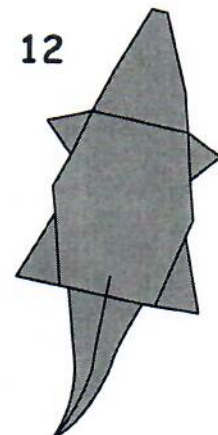

Finished Crocodile!

LET'S MAKE A GIRAFFE

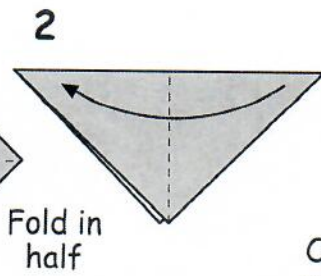
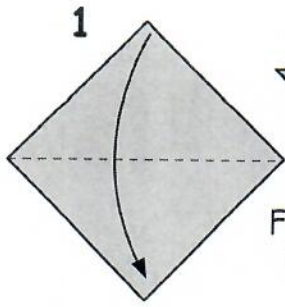

Fold in half

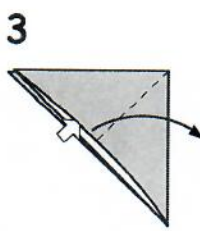

Open the ↑ part and flatten

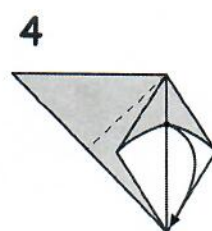

Flatten to square

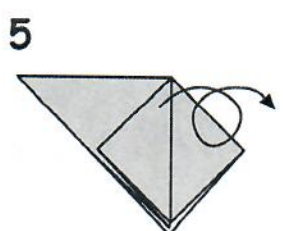

Turn over

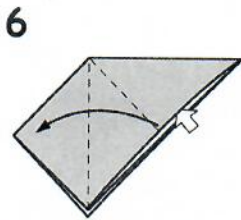

Open and flatten the pocket like Fig. 3 & 4



Fold to make a crease and fold back

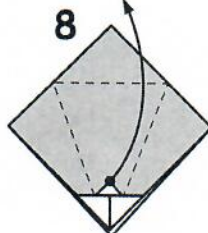

Lift the corner up to make pockets

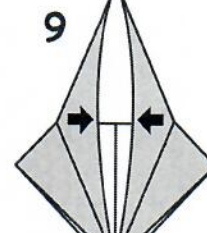

Flatten the pockets

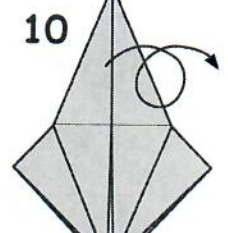

Turn over

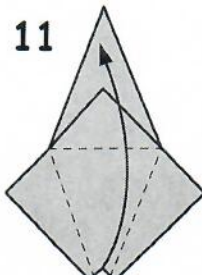

Lift the corner up to make pockets

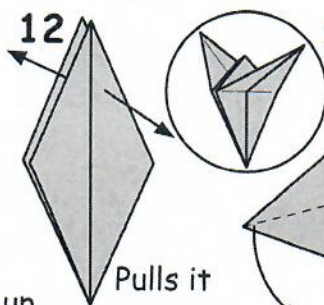

Pulls it

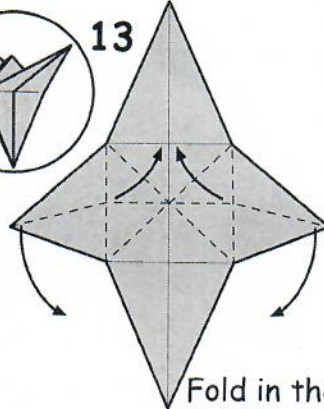

Fold in the lines

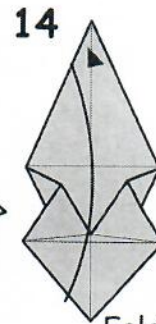

Fold

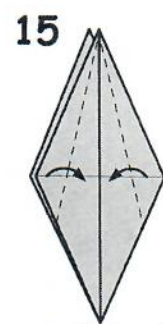

Fold in the dotted line



Fold in the dotted line



Fold backward in the dotted line

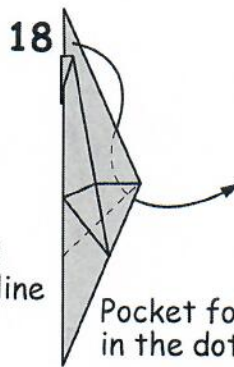

Pocket fold in the dotted line

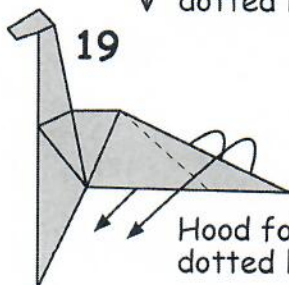

Hood fold in the dotted line

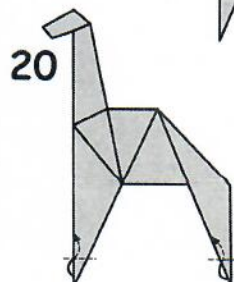

Pocket fold in the dotted line

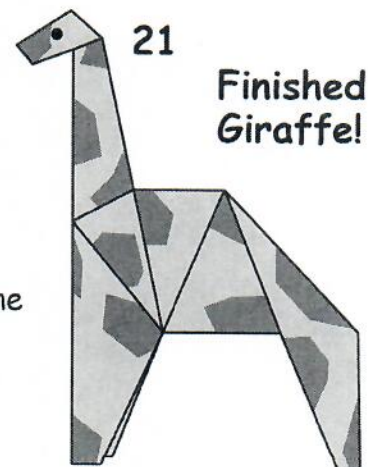

Finished Giraffe!

LET'S MAKE A RABBIT

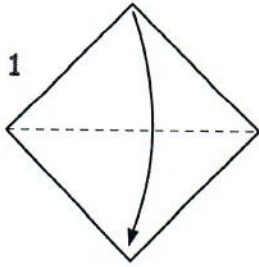

1
Fold the top corner down to the bottom and make a precise crease.

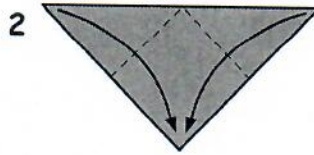

2
Fold both the top left and top right corners (blue dots) down to the bottom point (green dot) and crease well.

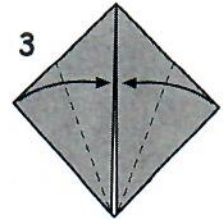

3
Fold down the top-right (blue dot) corner to make a diagonal fold. Unfold.

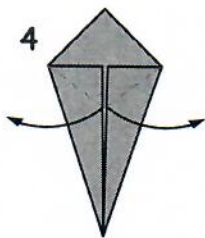

4
Start with the right flap. open it out to the right, pressing the top of it down to form a slanted triangle. Repeat on the left side.

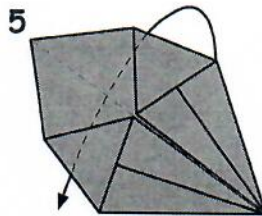

5
Rotate the paper to the left a little. Fold the top section backward and behind.

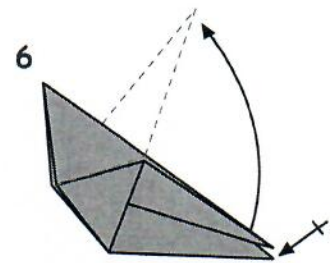

6
Take the flap, which is at the bottom right, and flip it up and behind. This is a rotation movement, not a reverse fold. Repeat on the flap on the back.

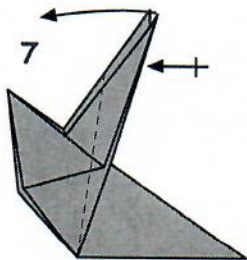

7
Fold the ears over to the left as indicated, the ears don't have to all be the same, as it's an animal, it looks nicer with some asymmetrical folds.

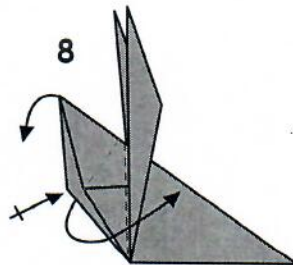

8
Hold onto the ears at the head. Open out the left sections. The nose should go downward, while the left flaps are pushed over the top of the ears on both the front and back of the rabbit.

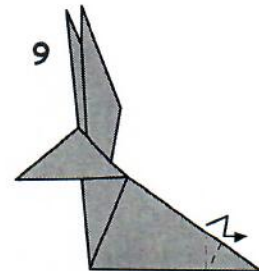

9
Make the two folds indicated and pleat fold them; the fold on the left is a mountain fold, while the diagonal fold is a valley fold. Open out the back of the rabbit to pleat fold them inside.

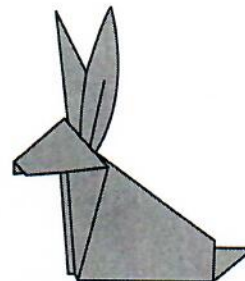
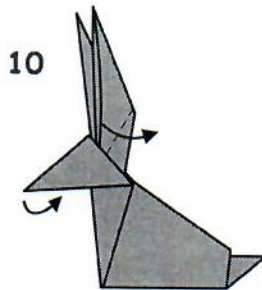

10
Fold the nose under. This is now complete, but we like to fold the ears back out a little. We also like to glue the flaps that stick out from the neck, depending on what type of paper you use.